

TM1700-series Circuit Breaker Analyzer System



- Provides reliable and accurate test results in noisy high voltage substations
- Five standard models. Full stand-alone functionality or data acquisition models without user interface.
- Fast and safer with DualGround™ testing, both sides of breaker grounded
- On-screen assistance with connection diagrams and test template Wizard
- All models can be controlled via computer

DESCRIPTION

The TM1700 series circuit breaker analyzers utilizes some of the ground breaking technology from the top of the line version TM1800. There are five models starting from PC-remote controlled to fully stand-alone. All models can be controlled from a computer using the well proven data management and analyzing software CABA Win.

The robust design offers powerful technology that assists the user to achieve efficient and reliable circuit breaker testing. All inputs and outputs on the instrument are designed to withstand the challenging environment in high-voltage substations and industrial environments. Galvanically isolated inputs and outputs makes it possible to perform all relevant measurements in one test, eliminating the need for new setup and re-connections.

The patented DualGround™ method makes the testing safe and time saving by keeping the circuit breaker grounded on both sides throughout the test.

The timing measurement inputs are using a patented Active Interference Suppression algorithm to ensure correct timing and accurate PIR (Pre-Insertion Resistor) values even at high capacitively coupled interference currents.

The adaptive and easy-to-use software allow the user to perform the test by simply turning the test switch without the need for settings. The operator is only one click away from advanced help functions such as connection diagrams. The 8" color touch screen, with on-screen keyboard, allows the user to efficiently operate this high-level interface.

SELECT – CONNECT – INSPECT

Working with TM1700 means fast and easy testing. Testing is done with a three-step process.

Select

First step is to select a suitable template from the template library depending on number of contacts per phase, motion or not, resistor contacts and more.

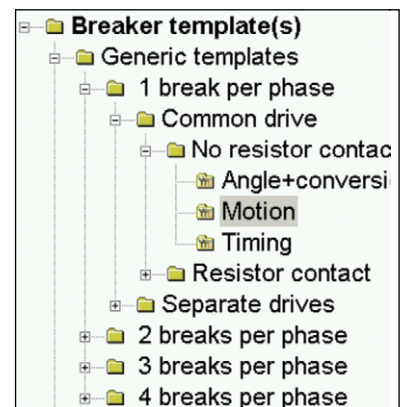

Connect

Second step is to connect the test leads according to the graphical help screen. Separate help screens for each cable.

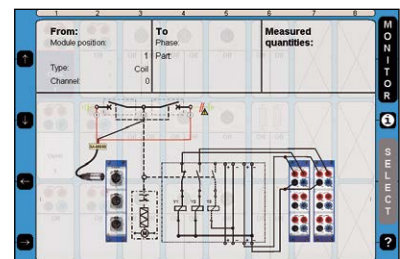

Inspect

Third step is to turn the "Measure" knob. The measurement is performed, analyzed and the results displayed on the screen. Magnification and compare functions are available..



TESTING WITH DUALGROUND

Electricity deregulation changes the business environment for utilities, switchgear owners and service companies. Deregulation has been shown to lead directly to increased emphasis on efficiency of operations, maintenance and service levels. Internationalization of business brings new challenges: substantial investments by global corporations will bring with them sharper or new requirements for increased emphasis on health, safety and environmental compliance. Experience has also shown there is less time for testing because the switchgear is less and less available to be taken out of service.

The safety aspect

Network operators and service companies need to maintain and develop their industry safety record. Eminent International bodies including the IEEE® and IEC®, National Safety agencies and Trade Unions increases the demands on safety. During the deregulation safety regulations have been clarified and the application of existing rules has been tightened. Keeping a good safety record is becoming a crucial asset to attract investors and customers.

In all substations the capacitive coupling from live high voltage conductors induce harmful/lethal currents in all parallel conductors. Grounding both sides of the test object will lead the induced current to earth and provide a safe area for the test personnel. See diagrams below.

Both sides grounded

The best way to provide safety in circuit breaker testing is to keep both sides of the circuit breaker grounded throughout the test. This will also make the test faster and easier. Testing personnel should spend the minimum time in the substation and their focus should be the test rather than the equipment.

The DualGround™ testing method is available for all tests on all circuit breakers.

Conventional vs. DualGround	
Site preparation (isolate work area, apply safety ground, issue permit to work)	Site preparation (isolate work area, apply safety ground, issue permit to work)
Hook up test equipment. Issue sanction for test	Hook up test equipment. Issue sanction for test
Authorised person removes the ground	Risky step left out
Perform testing	Safe testing with both sides grounded
Authorised person applies ground	Risky step left out
Cancel sanction for test. Disconnect test equipment	Cancel sanction for test. Disconnect test equipment
Site closing (cancel permit to work, disconnect ground)	Site closing (cancel permit to work, disconnect ground)



- Contact resistance **MJÖLNER / SDRM202**
- Timing **TM1700 with DCM**
- Motion **TM1700**
- SDRM **TM1700 with SDRM202**
- Vibration **CABA Win Vibration / SCA606**

Equipment and methods that support DualGround™ testing are associated with the DualGround symbol. This symbol certifies the use of ground-breaking technology and methods that enable a safe, fast and easy workflow with both sides grounded throughout the test.

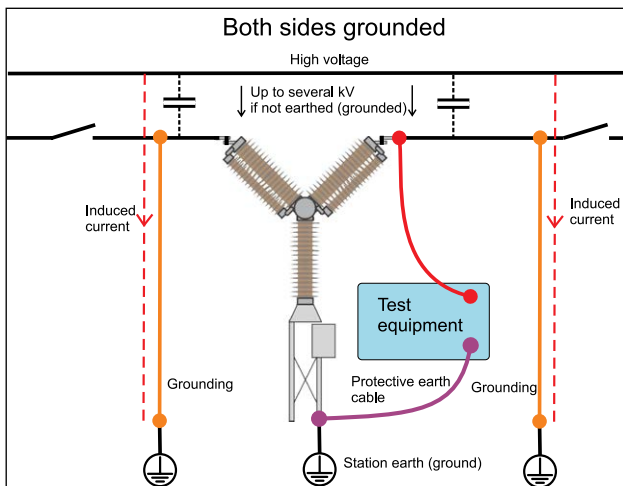

Testing is much safer using the DCM module and DualGround.

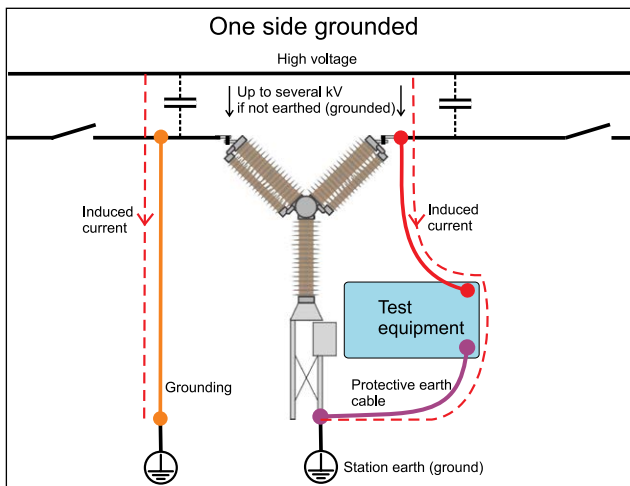

With only one side grounded the induced current can reach values high enough to be harmful or lethal for humans.

FEATURES AND BENEFITS

1. Input for external clamp-on CT
2. Control section
 - Three independent contact functions
 - Pre-programmed sequences C, O, C-O, O-C, O-C-O
 - Timing of a and b auxiliary contacts
 - Coil current, voltage and resistance
3. Timing Aux section
 - Six galvanic isolated channels
 - Polarity insensitive
 - Dry and wet auxiliary contacts
4. Timing M/R section
 - Six inputs
 - High resolution 15µV and up to 40 kHz sampling
 - Main and parallel resistor contact timing
 - Resistance value of parallel resistors
5. Analog section
 - Six channels (three optional)
 - Supports industrial analog transducers
 - Insulated channels, measure up to 250 V without volt. div.
 - High resolution 0.3 mV, sampling rate 40 kHz
6. Digital section
 - Six channels
 - Incremental transducers with RS422
 - Up to ±32000 pulses resolution
 - Up to 40 kHz sampling
7. Mains input
8. DC out
 - General voltage source ,12 V
9. DRM
10. Earth (ground) terminal
11. Ethernet port
12. USB ports
13. Trig IN
 - Used for external trig of the unit. Contact make / break or voltage signal.
14. DCM interface
15. Navigation buttons
 - Works in parallell with the touch screen buttons.
 - Most of the CABA Local functions are controlled by the ten navigation buttons.
16. Touch screen On/Off
17. On-screen keyboard On/Off
18. Display (touch screen)
 - High brightness for good visibility in direct sunlight.
19. Brightness setting
20. POSITION
 - Indicates the position of the circuit breaker main contacts if the coil circuit is connected to the control section.
21. SEQUENCE
 - Indicates the next operation of the circuit breaker. If Auto-detect breaker state is enabled in CABA Local or CABA Win, only possible sequences for the circuit breaker are selectable.
22. OPERATE/MEASURE
 - Initiates the selected operation sequence and makes the measurement. Green "READY" LED must be lit before turning the rotary switch. The yellow "OPERATING" LED is lit as long as the sequence is performed.
23. On/Off switch

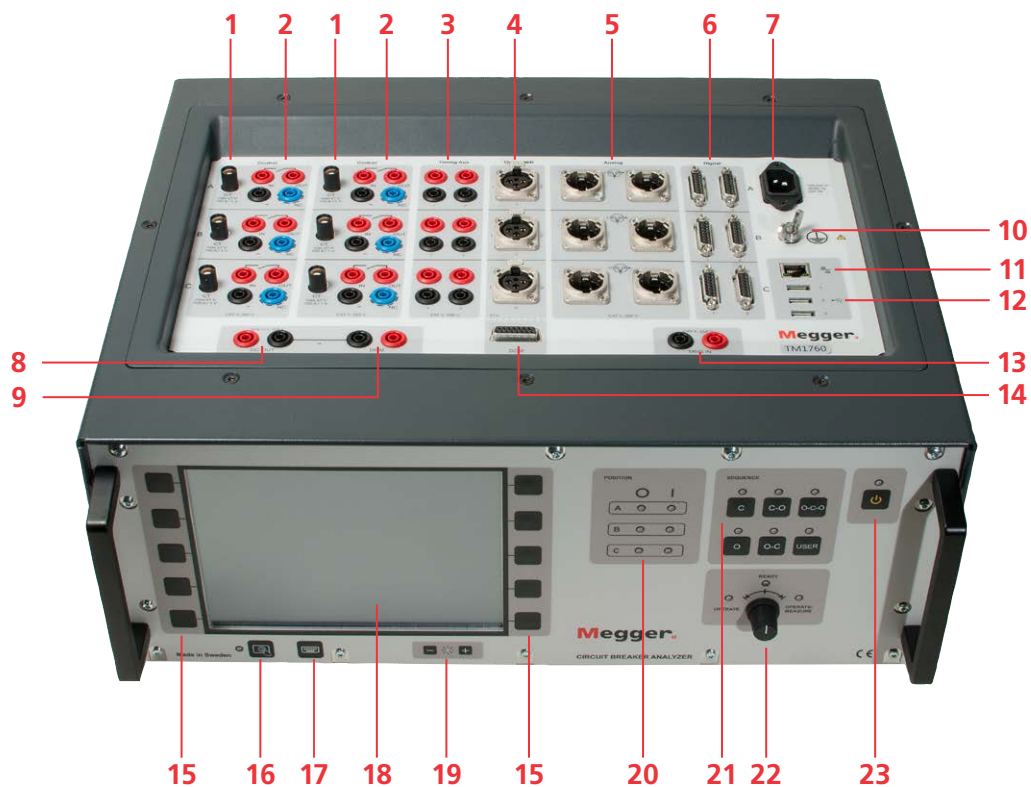

APPLICATION EXAMPLES

First trip measurement

When a fault occurs on a transmission or distribution line, the mission for the circuit breaker is to open the circuit to isolate the fault from the power source. A quick interruption of the current will avoid or limit damage to expensive equipment caused by the high fault currents.

Why capture first trip

Testing circuit breakers can be done in many ways, but one of the most common is timing of the main contacts, which gives a direct indication of the trip time. A typical procedure for performing a timing test on a circuit breaker is:

1. Open the CB
2. Disconnect the CB by opening the disconnecter switches
3. Ground the CB
4. Perform the timing test

Will the timing tests show the true trip time? Well, not necessarily. Consider a circuit breaker that has been in service without operating for many months, even years, before it was taken out of service for testing. It might then be suffering from a lack of or dried grease and maybe corrosion in its bearings. These problems can, and most probably will, slow down the first operation.

The problem with this procedure is that the CB has been operated at least once before the testing procedure begins. This operation might be all it takes to “shake off” any corrosion problems or sticky bearings and bring the breaker’s trip time up to standard. So when the actual timing test is performed, no problem exists and the service engineer thinks the breaker is in good shape and no further service is needed. Some months later the corrosion is back and when a fault occurs the CB does not trip fast enough, or maybe not at all. This is why it is important to capture the first operation to reveal any problems with the CB.

Methods

The “First Trip” measurement is a part of on-line testing, which means that the circuit breaker is in service. We will focus on three measurements; coil currents, control voltage and contact timing. However, other measurements that are possible on-line are auxiliary contact timing, vibration, motor currents and motion.

The coil currents are measured to give indication of any lubrication problems inside the main bearings or in the trip latch. By analyzing the coil currents, indication of changes in resistance can also be detected. They are caused by short-circuited windings, burnt coils etc. The coil currents can be measured with either current clamps or with the analyzers control module, if the utility allows a local breaker operation.

The control voltage is measured during the operation to give an indication of a weak battery bank. The station’s battery voltage before an operation might be in order, and is monitored by the charging units. However, during the operation the power demand might be too great for the bank.

- If the voltage drop is greater than 10% of the nominal voltage, it might be a sign of a failing battery bank.
- If the circuit breaker has three operating mechanisms, the coil currents and control voltages should be measured in each mechanism.

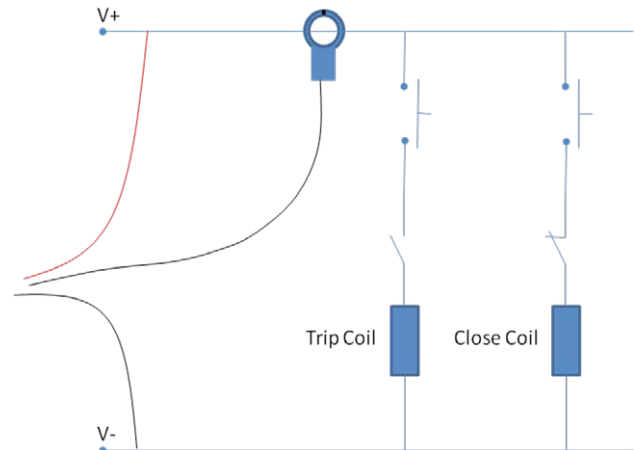

Figure 1 Point for measuring coil current and control voltage
Since the breaker is in service, the conventional way of measuring the times of the main contacts with timing leads across the interrupter cannot be used. Instead of timing leads, three current clamps are used. These current clamps are used on the secondary side of the current transformer for each phase. These show the current flowing through each phase and by looking for the instant when the current stops flowing, the breakers trip time is revealed.

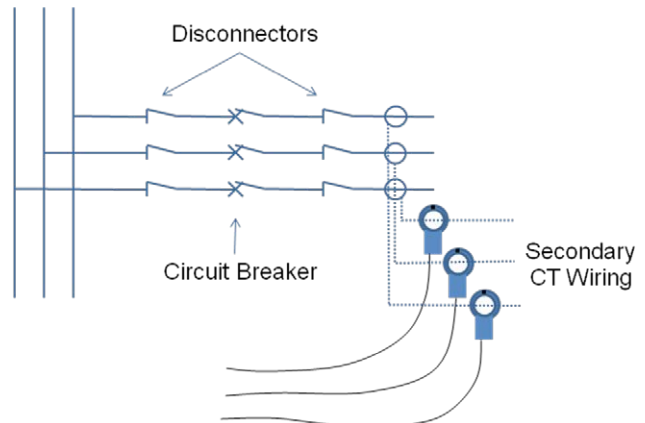

Figure 2 Point for measuring the line currents



Figure 3 Control cabinet with current clamps

Equipment

The equipment needed for a first trip measurement depends on the configuration of the circuit breaker. A common denominator for all measurements is the three current clamps for the line current are needed to capture the timing of the individual phases. These do not need to be able to measure DC currents, since they will only

measure the alternating line currents. For the coil current, either one or three clamps are needed depending on the number of operating mechanisms. These need to be able to measure both AC and DC to cover all types of coils, however DC coils being the most common.

Analysis

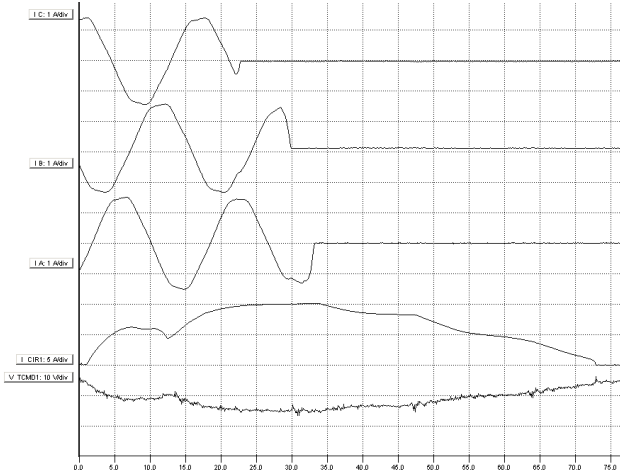

Figure 4 Example of measurement result
In figure 4, we see an example of a measurement that covers the three phases, one coil current and the control voltage.

Timing measurements

Simultaneous measurements within a single phase are important in situations where a number of contacts are connected in series. The breaker becomes a voltage divider when it opens a circuit. If the time differences are too great, the voltage becomes too high across one contact, and the tolerance for most types of breakers is less than 2 ms.

The time tolerance for simultaneous measurements between phases is greater for a 3-phase power transmission system running at 50Hz since there is always 3.33 ms between zero-crossovers. Even so the time tolerance is usually specified as less than 2 ms for such systems. It should also be noted that breakers that perform synchronized breaking must meet more stringent requirements.

There are no generalized time limits for the time relationships between main and auxiliary contacts, but it is important to understand and check their operation. The purpose of an auxiliary contact is to close and open a circuit. Such a circuit might enable a closing coil when a breaker is about to perform a closing operation and then open the circuit immediately after the operation starts, thereby preventing coil burnout.

The "a" contact must close well in advance of the closing of the main contact. The "b" contact must open when the operating

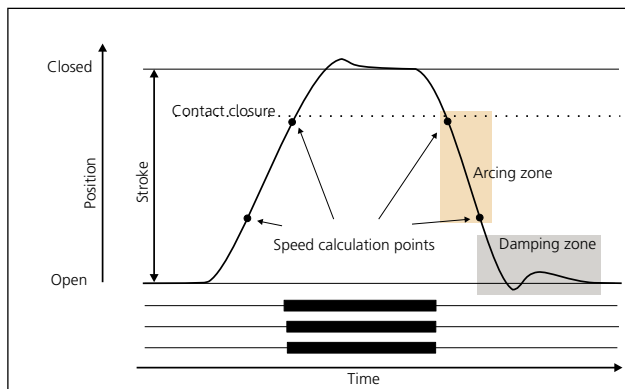

Motion diagram and timing graphs for a close-open operation

mechanism has released its stored energy in order to close the breaker. The breaker manufacturer will be able to provide detailed information about this cycle.

Motion measurements

A high-voltage breaker is designed to interrupt a specific short-circuit current, and this is required to operate at a given speed in order to build up an adequate cooling stream of air, oil or gas (depending on the type of breaker). This stream quenches the electric arc sufficiently to interrupt the current at the next zero-crossover. It is important to interrupt the current in such a way that the arc will not re-strike before the breaker contact has entered the so-called damping zone.

Speed is calculated between two points on the motion curve. The upper point is defined as a distance in length, degrees or percentage of movement from a) the breaker's closed position, or b) the contact-closure or contact-separation point. The lower point is determined based on the upper point. It can either be a distance below the upper point or a time before the upper point. The time that elapses between these two points ranges from 10 to 20 ms, which corresponds to 1-2 zero-crossovers.

The distance throughout which the breaker's electric arc must be extinguished is usually called the arcing zone. From the motion curve, a velocity or acceleration curve can be calculated in order to reveal even marginal changes that may have taken place in the breaker mechanics.

Damping is an important parameter for the high energy operating mechanisms used to open and close a circuit breaker. If the damping device does not function satisfactorily, the powerful mechanical strains that develop can shorten breaker service life and/or cause serious damage. The damping of opening operations is usually measured as a second speed, but it can also be based on the time that elapses between two points just above the breaker's open position.

Coil currents

These can be measured on a routine basis to detect potential mechanical and electrical problems in the actuating coils well in advance of their emergence as actual faults. The coil's maximum

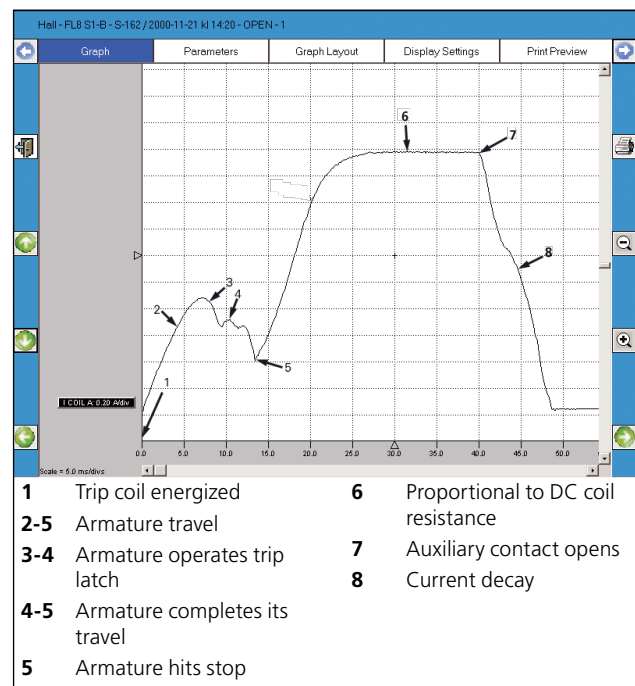

Example of coil current on circuit breaker

current (if the current is permitted to reach its highest value) is a direct function of the coil's resistance and actuating voltage. This test indicates whether or not a winding has been short-circuited.

When you apply a voltage across a coil, the current curve first shows a straight transition whose rate of rise depends on the coil's electrical characteristic and the supply voltage (points 1-2). When the coil armature (which actuates the latch on the operating mechanism's energy package) starts to move, the electrical relationship changes and the coil current drops (points 3-5). When the armature hits its mechanical end position, the coil current rises to the current proportional to the coil voltage (points 5-7). The auxiliary contact then opens the circuit and the coil current drops to zero with a current decay caused by the inductance in the circuit (points 7-8).

The peak value, of the first lower current peak, is related to the fully saturated coil current (max current), and this relationship gives an indication of the spread to the lowest tripping voltage. If the coil was to reach its maximum current before the armature and latch start to move, the breaker would not be tripped. It is important to note that the relationship between the two current peaks varies, particularly with temperature. This also applies to the lowest tripping voltage.

Dynamic resistance measurement (DRM)

A circuit breaker will have arcing contact wear from normal operation as well as from breaking short-circuit currents. If the arcing contact is too short or in bad condition the breaker soon becomes unreliable. Main contact surfaces can be deteriorated by arcing, resulting in increased resistance, excessive heating and in worst-case explosion.

The main contact resistance is measured dynamically over an open or close operation in DRM. With DRM measurement the arcing

contact length can be reliably estimated. The only real alternative to finding the length of the arcing contact is dismantling the circuit breaker.

A reliable DRM interpretation requires high test current and a circuit breaker analyzer with good measurement resolution.

Vibration analysis

Vibration analysis is a non-invasive method using an acceleration sensor without moving parts. The breaker can stay in service during the test. An Open-Close operation is all that is required for the measurement. The first operation can be compared to the second and third and will vary due to corrosion and other metal to metal contact issues. Vibration is an excellent method to capture the first operation after long time in the same position.

The analysis compares the vibration time series with a previously recorded reference trace. The vibration method detects faults that can hardly be founded with conventional methods. But if conventional data such as contact time, travel curve, coil current and voltage are available in addition to the vibration data even more precise condition assessment is possible. The vibration data is stored together with available conventional data.

The Vibration method is published in CIGRÉ and IEEE® papers. For about 15 years it has been in the industry for testing all kind of breakers from 400 kV distribution to smaller industrial ones. The method was first established in Scandinavia. Vibration can be performed very safely for the test technician as both sides can be grounded throughout the test. Less climbing is required as no access to the breaker contact system is needed, the acceleration sensor is easily mounted on the breaker.

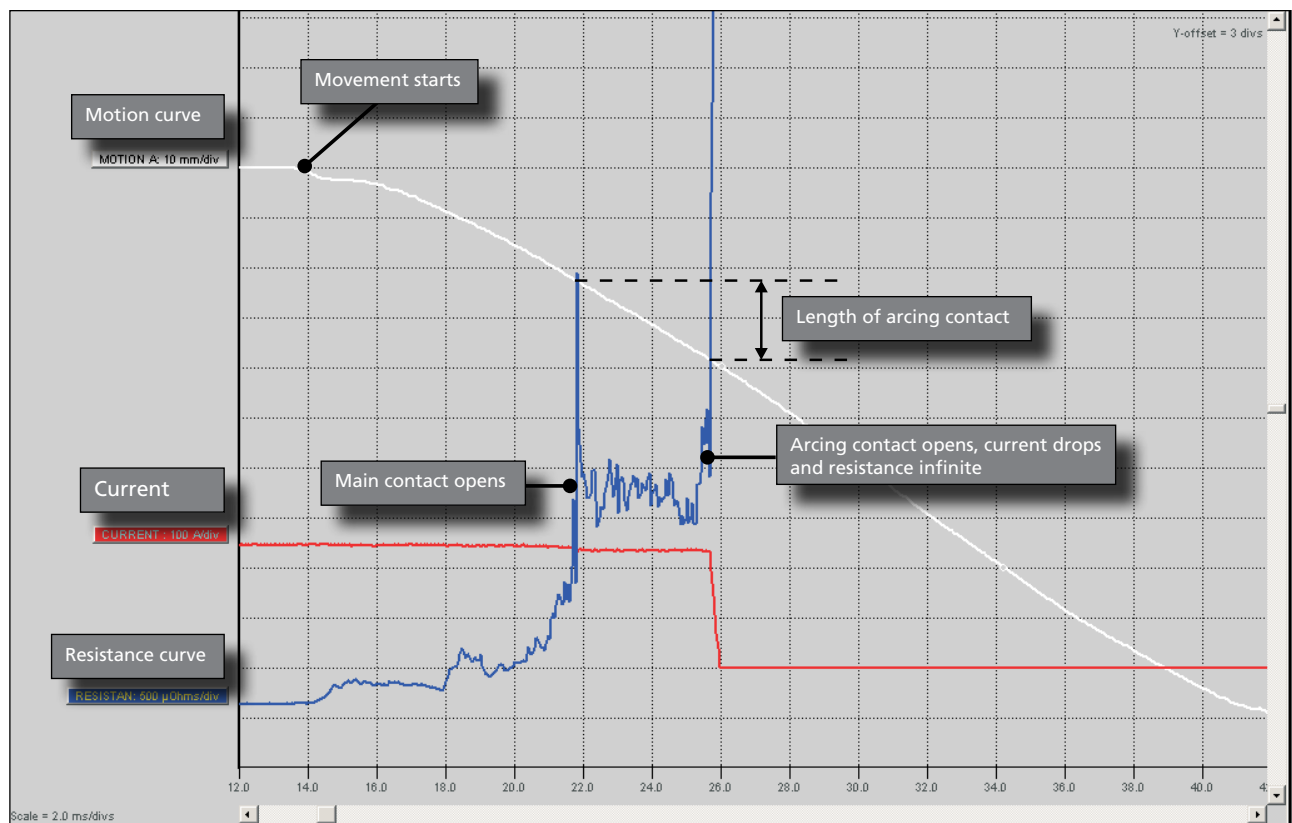

DRM is a reliable method to estimate the length/wear of the arcing contact. The SDRM202 provides high current and the TM1700 gives an accurate measurement with very good resolution. Besides, it is possible to use DualGround testing.

SPECIFICATIONS TM1700-SERIES

Specifications are valid after 30 minutes warm up time.
System time base drift 0.001% per year.
Specifications are subject to change without notice.

Environment

Application field For use in high-voltage substations and industrial environments

Temperature

Operating -20°C to +50°C (-4°F to +122°F)

Storage & transport -40°C to +70°C (-40°F to +158°F)

Humidity 5% – 95% RH, non-condensing

CE-marking

EMC 2004/108/EC

LVD 2006/95/EC

General

Mains input (nominal) 100 – 240 V AC, 50/60 Hz

Power consumption 200 VA (max)

Dimensions 500x185x410 mm (19.7" x 7.3" x 16.1")

Weight 12 kg (26.5 lbs)

External input

TRIG IN

Voltage mode

Input range 0 – 250 V AC/DC

Threshold level User configurable in software in steps of 1 V

Contact mode

Open circuit voltage 30 V DC $\pm 15\%$

Short circuit current 10 – 40 mA

Threshold level 1 – 2 k Ω

External outputs

DC OUT

General voltage source 12 V $\pm 10\%$, short circuit protection 1.7 A

DRM only for SDRM202 and DRM1800

Voltage mode

Output Voltage 12 V DC $\pm 10\%$

Short circuit protection PTC 750 mA

Switching current < 750 mA, resistive load

Communication interfaces

USB Universal Serial Bus ver. 2.0

Ethernet 100 base-Tx Fast Ethernet

HMI, Human-Machine interface

CABA Local Circuit breaker analyzing software

Available languages English, French, German, Russian, Spanish, Swedish. Translation kit available

Display High brightness SVGA 800x600, Touch screen

Diagonal size 21 cm (8")

Keyboard On screen

Control section (1 or 2)

General

No. of channels 3

Time base inaccuracy $\pm 0.01\%$ of reading ± 1 sample interval

Max. sample rate 40 kHz

Measurement time 200 s at 10 kHz sample rate,

Non-bouncing switch

Max current 60 A AC/DC, pulse ≤ 100 ms

Duration User configurable in steps of 1 ms

Delay User configurable in steps of 1 ms

Current measurement

Measurement range 0 to ± 80 A AC/DC

Resolution 16 bits

Inaccuracy $\pm 2\%$ of reading $\pm 0.1\%$ of range

External current measurement

CT

Max input ± 1 V

Scaling 100 A / 1 V

Range ± 80 A V / ± 0.8 V

Voltage measurement

Measurement range 0 – 250 V AC, 0 – 350 V DC

Resolution 12 mV

Inaccuracy $\pm 1\%$ of reading $\pm 0.1\%$ of range

Timing M/R section (1)

General

No. of channels 6

Time base inaccuracy $\pm 0.01\%$ of reading ± 1 sample interval

Min. resolution 0.05 ms

Max. sample rate 40 kHz

Measurement time 200 s at 20 kHz sample rate

Timing of main and resistive contacts

Open circuit voltage 6 V or 26 V $\pm 10\%$ (Toggling at every second sample)

Short circuit current 9.7 mA or 42 mA $\pm 10\%$

Status threshold

Main Closed < 10 Ω < Open

Main and Resistor Main < 10 Ω < PIR < 10 k Ω < Open

PIR resistance measurement

Supported PIR types Linear PIR

Measurement range 30 Ω – 10 k Ω

Inaccuracy $\pm 10\%$ of reading $\pm 0.1\%$ of range

Voltage measurement

Measurement ranges ± 50 V_{peak}, ± 15 V_{peak}, ± 0.5 V_{peak}

Resolution 16 bits

Inaccuracy $\pm 1\%$ of reading $\pm 0.1\%$ of range

Analog section (none, 1 or 2)

General

No. of channels 3 isolated channels

Time base inaccuracy $\pm 0.01\%$ of reading ± 1 sample interval

Max. sample rate 40 kHz

Measurement time 200 s at 10 kHz sample rate

Transducer resistance 500 Ω – 10 k Ω at 10 V output

Output

Voltage output 10 V DC $\pm 5\%$, 24 V DC $\pm 5\%$

Max. output current 30 mA

Current measurement

Measurement range ± 22 mA

Resolution 16 bits

Inaccuracy $\pm 1\%$ of reading $\pm 0.1\%$ of range

Voltage measurement

Input voltage range 0 – 250 V AC, 0 – 350 V DC

Measurement ranges ± 10 V DC, 0 – 250 V AC/DC

Resolution 16 bits

Inaccuracy

250 V range $\pm 1\%$ of reading $\pm 0.1\%$ of range

10 V range $\pm 0.1\%$ of reading $\pm 0.01\%$ of range

Digital section

General

No. of channels	6
Supported types	Incremental transducers, RS422
Time base inaccuracy	±0.01% of reading ±1 sample interval
Max. sample rate	40 kHz
Measurement time	200 s at 10 kHz sample rate

Output

Voltage	5 V DC ±5% or 12 V DC ±5%
Max. output current	700 mA

Digital input

Range	±32000 pulses
Resolution	1 pulse
Inaccuracy	±1 pulse

Timing Aux section

General

No. of channels	6 isolated channels
Time base inaccuracy	±0.01% of reading ±1 sample interval
Max. sample rate	40 kHz
Measurement time	200 s at 10 kHz sample rate

Voltage Mode

Input voltage range	0 – 250 V AC, 0 – 350 VDC
Status threshold	±10 V
Inaccuracy	±0.5 V

Contact mode

Open circuit voltage	25 – 35 V DC
Short circuit current	10 – 30 mA DC
Status threshold	Closed < 100 Ω, Open > 2 kΩ

DCM module (Optional)

General

No. of channels	6
Weight	0.6 kg (1.4 lbs)

Output

Voltage	0 - 5 V rms AC
Current	0 - 70 mA rms AC

OPTIONAL ACCESSORIES

Item	Description	Art. No.
Software and application kits		
CABA Win – Circuit Breaker analysis software		
<i>CABA Win</i>	incl. Ethernet cross-over cable	CG-8000X
<i>CABA Win upgrade</i>	Upgrade to latest version	CG-8010X
Vibration analysis		
<i>Vibration kit</i>	The Vibration kit extends TM1700 and CABA Win with the equipment and software required for recording and analyzing vibration signals at a circuit breaker. The kit includes the signal conditioning unit SCA606, the software CABA Win Vibration and one vibration channel. The vibration solution can be extended up to 6 channels.	BL-13090
<i>Vibration channel</i>	Additional vibration channel to be used together with the Vibration kit. Each Vibration channel includes accelerometer, accelerometer adapter, cables to SCA606 and cables to TM1700-series.	XB-32010
Synchronized Switching Relay test kit		
<i>SSR kit</i>	Incl. accessories, software and cables (delivered in transport case)	CG-91200
1:st trip kits	For single operating mechanism	BL-90700
	For three operating mechanisms	BL-90710
DCM (Dynamic Capacitance Measurement)		
DCM1700		
	The DCM1700 is used for timing using the DualGround™ method. Safe testing with both sides grounded.	
<i>DCM1700 3 ch</i>	Kit for 3-channels DualGround™ Timing	BL-59190
<i>DCM1700 6 ch</i>	Kit for 6-channels DualGround™ Timing	BL-59192
SDRM (Static and Dynamic Resistance Measurement)		
<i>SDRM202</i>	The SDRM202 uses new technology, patent pending, with ultra capacitors. The current output is up to 220 A from a box that weighs only 1.8 kg (4 lbs). The weight of the current cables is also low because the SDRM202 is placed very close to the circuit breaker. Timing M/R measurement can be done with the same hook-up	CG-90200
<i>SDRM202 Pack of 3 units</i>	Pack for CB with 2 Breaks / Phase	CG-90230
<i>Extension cable SDRM202</i>	7.5 m (24 ft)	GA-12815
	10 m (33 ft)	GA-12810

Item	Description	Art. No.
Transducers		
Linear – Analog		
<i>TLH 500</i>	500 mm (20") travel Incl. cable 0.5 m (20")	XB-30020
<i>LWG 225</i>	225 mm (9") travel Incl. cable 0.5 m (20")	XB-30117
<i>TS 150</i>	150 mm (5.9") travel Incl. cable 1.0 m (3.3 ft)	XB-30030
<i>TS 25</i>	25 mm (1") travel Incl. cable 1.0 m (3.3 ft)	XB-30033
Linear – Digital		
<i>TP1 300</i>	300 mm (11.8") travel Incl. cable 10 m (33 ft)	XB-39140
<i>TP1 500</i>	500 mm (17.7") travel Incl. cable 10 m (33 ft)	XB-39150
<i>Link</i>	300 mm (11.8") for position marker	XB-39193
The above transducers are also available in other lengths, please contact Megger for information.		
Rotary - Analog		
<i>Novotechnic IP6501</i>	Incl. cable 1 m (3.3 ft), 6 mm Flex coupling, Hexagon wrench	XB-31010
<i>Flex coupling</i>	For IP6501, shaft diam. 6 mm	XB-39030
Rotary – Digital		
<i>Baumer</i>	BDH16.05A3600-LO-B Incl. cable 10 m (33 ft), 10/6 mm Flex coupling, Hexagon wrench	XB-39130
Transducer mounting kits		
Universal kits		
<i>Rotary transducer mounting kit</i>	For transducers XB-31010 and XB-39130	XB-51010
<i>Universal transducer mounting kit</i>	For linear and rotary transducers	XB-51020
Circuit breaker specific kits		
<i>LTB Kit (ABB)</i>	Incl. mounting kit XB-51010, Software conversion table BL-8730X	XB-61010
<i>HPL/BLG Kit (ABB)</i>	Incl. mounting kit XB-51010, Software conversion table BL-8720X	XB-61020
<i>AHMA 4/8 (ABB)</i>	Incl. 3 transducers	XB-61030
<i>HMB 4/8 (ABB)</i>	Incl. 3 transducers	XB-61040
Ready-to-use kits – Rotary – Analog		
<i>1-phase kit</i>	Incl. transducer XB-31010, mounting kit XB-51010	XB-71010
<i>3-phase kit</i>	Incl. 3 x 1-phase kits XB-71010	XB-71013
Ready-to-use kits – Rotary – Digital		
<i>1-phase kit</i>	Incl. transducer XB-39130, mounting kit XB-51010	XB-71020
<i>3-phase kit</i>	Incl. 3 x 1-phase kits XB-71020	XB-71023

Item	Description	Art. No.
Transducer mounting accessories		
<i>Universal support</i>		XB-39029
<i>Switch magnetic base</i>		XB-39013
<i>Thread adapter kit</i>	Metric to Imperial TLH / TP1	XB-39036
Cables		
<i>DCM 3-channel addition</i>	3 DCM cables, 12 m (39 ft, 6 clamps (DualGround timing)	CG-19180
<i>DCM 3-channel extension cable</i>	3 DCM extension cables, 10 m (33 ft) GA-00999 (DualGround timing)	CG-19181
<i>Cable reel 20 m (65.5 ft), 4 mm stackable safety plugs</i>	Black	GA-00840
	Red	GA-00842
	Yellow	GA-00844
	Green	GA-00845
	Blue	GA-00846
<i>Extension cables, XLR female to male</i>	For analog input, 10 m (33 ft)	GA-01005
<i>Open analog cable</i>	For Timing M/R modules, 10 m (33 ft)	GA-00851
<i>Open analog cable</i>	For customized analog transducer connection	GA-01000
<i>XLR to 4 mm safety plugs</i>	For customized analog transducer connection	GA-00040
<i>Digital transducer extension cable</i>	RS422, 10 m (33 ft)	GA-00888
<i>Open digital cable</i>	For customized digital transducer connection	GA-00885
<i>L & L digital cable</i>	For using Leine & Linde 530 digital transducer	GA-00890
<i>Baumer digital cable</i>	For using Baumer digital transducer	GA-00895
<i>Doble cable</i>	Adapter for Doble transducer	GA-00867
<i>Siemens cable</i>	Adapter for Siemens transducer	GA-00868
<i>Vanguard cable</i>	Adapter for Vanguard transducer	GA-00869
<i>TP1</i>	Digital cable	GA-00889
<i>Ethernet cable, network</i>	Cable for connection to network/LAN	GA-00960
Other		
<i>LTC135</i>	Load Tap Changer power supply	CG-92100
<i>Current sensor</i>	Current sensor kit 1 channel (Fluke 80i-110s incl. cable GA-00140)	BL-90600
	Current sensor kit 3 channels (Fluke 80i-110s incl. cables GA-00140)	BL-90610
<i>Transport case</i>		GD-00025
<i>Cable organizer</i>	Velcro straps, 10 pcs.	AA-00100

For more information about optional accessories please contact Megger Sweden AB



Rotary transducer, Novotechnic IP6501 (analog)



Rotary transducer, Baumer BDH (digital)



Linear transducer, LWG 150



Linear transducer, TS 25



Switch magnetic base



Vibration kit, BL-13090 Includes: SCA606, CABA Win Vibration software and one Vibration channel



Linear transducer, TLH 225

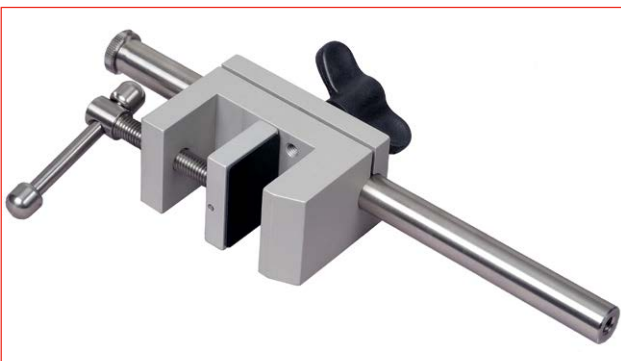

Universal support



Linear transducer, TP1 300 (digital)



Rotary transducer mounting kit, XB-51010



Cable reels, 20 m (65.5 ft), 4 mm stack-able safety plugs



SDRM202



DCM1700, for timing using the DualGround™ method. Safe testing with both sides grounded.



SDRM Cable



Cable XLR, GA-00760



Extension cable XLR, GA-01005



LTC135, Load Tap Changer power supply

TM1700 – MODELS

TM1710



Including:

- Control 3 ch. (Auxiliary 3 ch.)
- Timing M/R 6 ch.
- Digital 6 ch.
- CABA Win

Optional:

- Analog 3 ch., DCM 6 ch.

TM1720

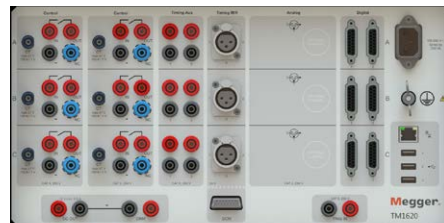

Including:

- Control 6 ch. (Auxiliary 6 ch.)
- Auxiliary 6 ch.
- Timing M/R 6 ch.
- Digital 6 ch.
- CABA Win

Optional:

- Analog 3 ch., DCM 6 ch.

TM1740



Including:

- Control 3 ch. (Auxiliary 3 ch.)
- Timing M/R 6 ch.
- Digital 6 ch.
- CABA Win

Optional:

- Analog 3 ch., DCM 6 ch.

TM1750



Including:

- Control 6 ch. (Auxiliary 6 ch.)
- Auxiliary 6 ch.
- Timing M/R 6 ch.
- Digital 6 ch.
- CABA Win

TM1760



Including:

- Control 6 ch. (Auxiliary 6 ch.)
- Auxiliary 6 ch.
- Timing M/R 6 ch.
- Digital 6 ch.
- Analog 3
- CABA Win

Optional:

- Analog 3 ch., DCM 6 ch.

ORDERING INFORMATION

Item	Art. No.
TM1710	BL-49090
With Analog option incl. analog cables	BL-49092
TM1720	BL-49094
With Analog option incl. analog cables	BL-49096
TM1740	BL-49190
With Analog option incl. analog cables	BL-49192
TM1750	BL-59090
TM1760	BL-59094
With Analog option incl. analog cables	BL-59096
Included accessories	
Soft case	
Test cables and clamps	
Protective earth (ground) cable	
Mains cable	
Bag for cables	
USB memory stick	
Ethernet cable	
CABA Win	
User's manual	

Item	Art. No.
Optional accessories	
DCM1700 3 ch	
Kit for 3-channels DualGround™ Timing	BL-59190
DCM1700 6 ch	
Kit for 6-channels DualGround™ Timing	BL-59192
Keyboard	HC-01090
Flight Case TM1700-series	GD-00025
Digital Linear Transducer	
TP1 300	XB-39140
TP1 500	XB-39150
Circuit breaker transducer kits	
AHMA 4/8 (ABB)	XB-61030
HMB 4/8 (ABB)	XB-61040
First trip kits	
For single operating mechanism	BL-90700
For three operating mechanisms	BL-90710
LTC135	
Load Tap Changer power supply	CG-92100
See Optional accessories pages for more information	

POSTAL ADDRESS

Megger Sweden AB
Rinkebyvägen 19
SE-182 36 DANDERYD
SWEDEN
+46 8 510 195 00
seinfo@megger.com

TM1700-series_DS_en_V08b

Art. No. ZI-BL14E ■ Doc.BL15891E ■ 2016
Subject to change without notice.

ISO 9001:2008

The word "Megger" is registered trademark
www.megger.com